



Aiko Energy PV module Installation Manual

Aiko Energy PV module Installation Manual

Aiko Energy reserves the right to change this Manual without prior notice.

Please check the latest version of the Installation Manual on the official website of Aiko Energy.

Website: <http://www.aikosolar.com/>

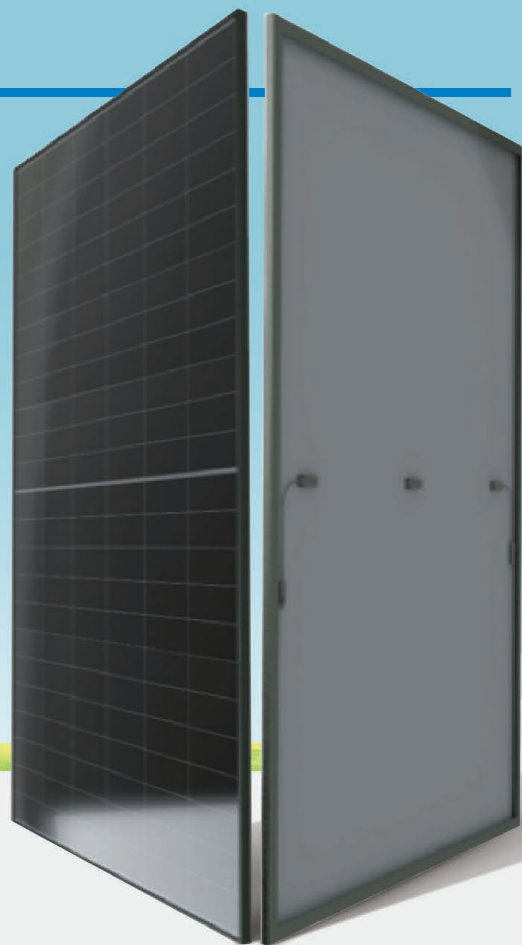

Applicable module models

Module structure

AIKO-Pxxx-MAH72Mw	AIKO-Pxxx-MAH72Mb
AIKO-Pxxx-MAH54Mw	AIKO-Pxxx-MAH54Mb
AIKO-Axxx-MAH72Mw	AIKO-Axxx-MAH72Mb
AIKO-Axxx-MAH54Mw	AIKO-Axxx-MAH54Mb
AIKO-Bxxx-MAH72Mw	AIKO-Bxxx-MAH72Mb
AIKO-Bxxx-MAH54Mw	AIKO-Bxxx-MAH54Mb

Single glass



Important safety instructions

- This Installation Manual provides information regarding the installation and safe use of PV power modules ("modules") produced by Shenzhen Aiko Digital Energy Technology Co., Ltd. ("Aiko Energy"). Installation and day-to-day maintenance of modules shall be in accordance with all safety precautions specified in this Manual and local laws.
- Installing module systems requires specialized skills and knowledge, and modules shall be installed and maintained by qualified persons. The installers shall be familiar with the mechanical and electrical requirements of the system. Please keep this Manual for future maintenance or treatment.

Contents

01 Overview	01	07 Grounding	15
02 Laws and acts	01	08 Maintenance of PV modules	16
03 General information	02	8.1. Cleaning	16
3.1. Module identification	02	8.2. Visual checks of the modules	17
3.2. Wiring method	03	8.3. Checks of connectors and cables	17
3.3. General safety	04	*Modified version and date	17
3.4. Electrical safety	04		
3.5. Handling safety	05		
3.6. Fire safety	06		
3.7. Storage and transportation instructions	07		
04 Installation conditions	09		
4.1. Location and working environment	09		
4.2. Tilt angle selection	10		
05 Mechanical installation	11		
5.1. General requirements	11		
5.2. Mechanical installation of single glass modules	11		
06 Electrical installation	13		
6.1. Electrical performance	13		
6.2. Cables and connections	14		
6.3. Connectors	14		

01 Overview

Thank you very much for choosing the products of Aiko Energy. This Installation Manual contains important information regarding electrical and mechanical installation which you shall know before installing modules. It also contains some other safety information that you must be familiar with.

This Installation Manual is not intended as any warranty, expressed or implied. Nor does it include any indemnification plan against loss, module damage or other expenses directly arising out of or in connection with the installation, operation, use or maintenance of modules. No responsibility will be assumed by Aiko Energy for any infringement of patents or other rights of third parties which may result from the use of PV modules. Aiko Energy reserves the right to make revisions to the product specification and this Installation Manual without prior notice. Aiko Energy reserves the right to make revisions to the product specification and this Installation Manual without prior notice.

Customer's failure to install modules according to the requirements listed in this Installation Manual will invalidate the limited product warranty offered to customer. Recommendations in this Manual are provided to improve installation safety, and are based on tests and practical experience. Please provide this Manual to end customers (or consumers) and inform them of all safety, operation and maintenance requirements and recommendations.

02 Laws and acts

Mechanical and electrical installations of PV modules shall be executed by referring to the applicable laws and acts, including the electrical act, building act and electrical connection requirements. These requirements vary from one location to another, such as building rooftop installations and onboard applications. They may also vary with mounting system voltage and current property (DC or AC). Please contact your local authority for further details.

03 General information

Disclaimer

Aiko Energy reserves the right to change this Manual without prior notice. This Installation Manual is not a warranty and does not carry the meaning of any warranty.

Failure to follow the requirements listed in this manual during the operation of the modules (including but not limited to product unpackaging/packaging, loading/unloading, transportation, storage, installation, use, operation or maintenance, etc.) will result in the product limited warranty void. Aiko Energy shall not be liable for any loss caused by any improper operation or failure of the customer to follow the instructions in this Manual, including but not limited to any product damage, personal injury or other property damage caused by the failure to follow the instructions in this Manual during the operation of the modules.

Structural diagram of single-glass modules and component description

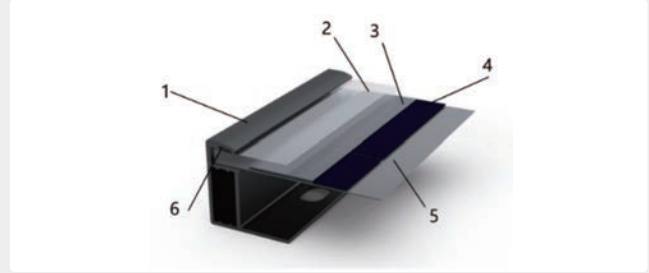
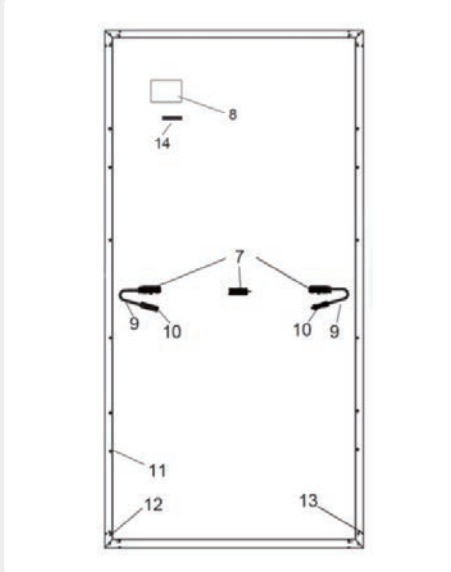

- | | | |
|------------------------|----------------|-------------------|
| 1 Aluminum alloy frame | 6 Silicone | 11 Mounting hole |
| 2 PV glass | 7 Junction box | 12 Grounding hole |
| 3 Adhesive film | 8 Nameplate | 13 Leak hole |
| 4 ABC cell | 9 Cable line | 14 Barcode |
| 5 Back cover | 10 Connector | |

Module identification 3.1

Aiko Energy modules provide two visual labels:

Nameplate Product type, information regarding the rated power, rated current, rated voltage, open circuit voltage, short circuit current, certification mark, maximum system voltage under standard test conditions (STC).

Serial number Each individual module is identified with a unique serial number which is printed on the barcode and placed into the module before lamination such that it cannot be torn or daubed after lamination. The same serial number can also be found elsewhere on the module.

Nameplate

Model: _____

Rated Maximum Power (P_{max})
 Power Tolerance
 Voltage at P_{max} (V_{mp})
 Current at P_{max} (I_{mp})
 Open-Circuit Voltage (V_{oc})
 Short-Circuit Current (I_{sc})
 Voc & Isc Tolerance
 Maximum System Voltage
 Maximum Series Fuse Rating
 Operating Temperature
 Protection Class

STC: AM-1.5, E=1000W/m², Tc=25°C

SHEKZHEN SOLAR GRID'S DIGITAL POWER TECHNOLOGIES CO.,LTD.
 Add: Room 607, Building B, Teagle Industrial Building, No.8 Lianhua Road, Futian District, Shenzhen
 Web: www.aikosolar.com

Made in China

Barcode labeling

M01220901P0020001

M011542112300011





Module color To ensure color consistency when the modules are used by customer, the box of modules is packed by color by marking the modules with S1, S2, S3, A, or B on the shipping mark of the box of modules.

Packing list of modules					
Maximum power	410 W	Grade	A	Module color	S1
Pallet number	<p>A122606002</p>				

Wiring method

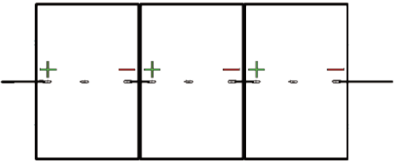
3.2

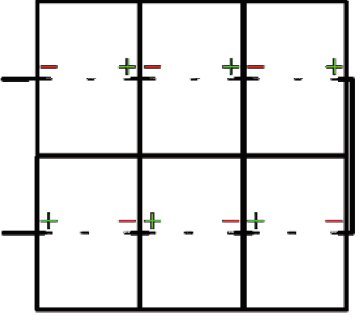
The junction box of Aiko Energy modules is located in the middle position. Please refer to the table below for how to connect Aiko Energy modules in series.

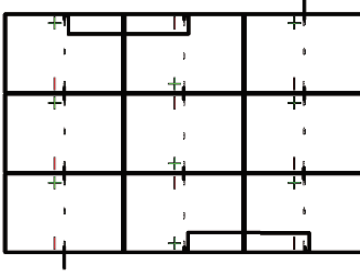
Position of junction box	Module mounting type	Connection diagram
	Mounting on the long side, single row	 <p>Horizontally adjacent modules are directly connected at the shortest distance or, if the wire is too long, by placing the wire into the secondary beam.</p>
	Mounting on the long side, double rows	 <ol style="list-style-type: none"> 1. Horizontally adjacent modules are directly connected at the shortest distance or, if the wire is too long, by placing the wire into the secondary beam; 2. Connections between adjacent rows of modules shall be designed and installed by considering the opposite polarity on the same side as shown below. Adjacent modules are side connected by routing the wire through a duct instead of using an uncovered wire.
	Mounting on the short side, single row	 <p>In vertical installation, connections between vertically adjacent modules are designed and installed with opposite polarities between adjacent modules as shown and the extension line can be placed into the secondary beam.</p>
	Mounting on the short side, multiple rows	 <ol style="list-style-type: none"> 1. Vertically adjacent modules as shown below are connected at the shortest distance; 2. Connections between adjacent columns of modules shall be designed and installed by considering the opposite polarity on the same side as shown below. Adjacent modules may be side connected by placing the wire into the secondary beam.

General safety

3.3

Aiko Energy modules are designed to operate in application to class A according to IEC standards IEC-61215 and IEC-61730. Modules can be used in publicly accessible systems with DC voltage greater than 50 V or power greater than 240 W. Modules are designed with safety class II and fire class rating C.

- Always use appropriate protections such as insulated tools, safety helmets, insulating gloves, safety belts and safety insulating shoes when handling the module whether it is or not connected to the system. Please use the appropriate electrical safety tools when you need to install, ground, connect, clean or otherwise handle the module.
- PV modules will generate direct current while exposed to sunlight whether or not it is connected to the electrical system. Touching the live parts of the module (e.g., connectors) can result in casualties. Be sure to avoid direct contact with the module to avoid electrical shock or cut.
- Observe local laws and regulations at the location for module installation and obtain a building license or other qualifications where necessary.
- Modules shall be installed by qualified persons who have specialized skills and knowledge and are familiar with the mechanical and electrical requirements of the system. Potentially harmful risks during installation, including electrical shock and cut, shall be identified in advance.
- Rooftop systems can only be installed on roofs having passed the evaluation of construction experts with formal, full structural analysis results.
- Observe the safety rules for all mounting components. For example, wires and cables, connectors, charging controllers, inverters and batteries shall only be installed using equipment, connectors, wires and racks matching with the solar power system. If the PV system is equipped with a battery, the battery manufacturer's advice shall be followed.
- Only components of the same size and model can be connected together.



Electrical safety

3.4

Please strictly follow the electrical safety precautions below to avoid any form of electrical safety accident.

- Do not install or handle modules in periods of humidity or high winds.
- Modules can generate DC voltage exceeding 30 V. Take care to avoid direct contact.
- Make sure that the connecting cable is secured to the support frame for mounting modules.
- Cables must be protected in conduits in areas where they are accessible by animals or children.
- Do not artificially modify or remove any parts or labels from the module.
- Do not install modules without safety protections.
- Do not make electrical connection by means other than connectors.
- Broken modules have the risk of electric shock and fire and must be replaced immediately.
- Module arrays shall be installed when it is electrically safe to do so.
- During installation, the voltage of modules connected in series shall not exceed the maximum system voltage.
- Do not mate connectors from different manufacturers or of different models.
- Do not use conventional modules as a substitute for roof or wall materials.
- Do not connect or disconnect the module when there is current in the module or when an external current is present.
- Do not coat module surfaces with corrosive chemicals.
- Do not access modules while they are wet.

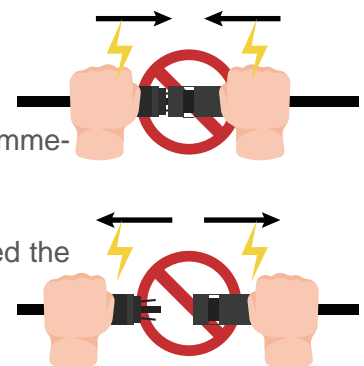

Handling safety

3.5

- Standing, stepping, sitting, walking or jumping directly on the module package or module is prohibited.



- Do not pile heavy objects on the module.



- Do not connect the positive and negative anode cables of the same PV module together;
- Do not open the packing box before the modules arrive at the location.
- Keep the packing box in a ventilated, dry environment. Be sure to avoid exposing modules to major vibration in all handling processes. Inappropriate handling and placement can result in breakage of glass or loss of electrical property, consequently the use value of the modules.
- Do not step, stand or sit on modules. This will damage the module and potentially cause injury.
- Do not place any heavy objects on the front or back of the module. Do not place the module on the surface of a sharp object.
- Do not attempt to disassemble the module, and do not remove any attached nameplates or components from the module.
- Do not apply paint or other adhesives to module top surface.
- Avoid scratching the back cover or glass surface of the module.
- Do not drill holes on the module frame. This will lead to degraded frame load handling capacities and frame corrosion, which will invalidate the limited warranty of the module.
- Do not scratch the anodized layer on the surface of the aluminum alloy frame. Scratching will lead to frame corrosion and deteriorate the load handling capacities and long-term reliability of the frame.
- Do not repair or modify the module by yourself.
- Accessible PV module surfaces shall be smooth and free of sharp edges or burrs.

Fire safety

3.6

- Please refer to local laws and regulations before installing any module and observe their building fire safety requirements.
- Rooftop installations shall be placed over fire resistant roof coverings appropriate for this rating, and adequate ventilation shall be provided between the back cover and the mounting surface. The roof structure and module mounting method will affect the fire safety performance of the building. Inappropriate installation can lead to fire risks.
- To guarantee the fire rating on roof, the module frame shall be sited a minimum of 10 cm from the roof surface.
- Please use the appropriate module accessories, e.g., fuses, circuit breakers and ground connectors, according to local laws and regulations.
- Do not use modules if there is an exposed combustible gas in the vicinity.

Storage and transportation instructions 3.7

Considerations for module turnover and transportation 3.7.1

- When the modules arrive, please timely check whether the outer box of the package is in good condition, and check whether the module model and quantity on the outer package are consistent with the delivery note. If any abnormality is found, please contact the logistics personnel and Aiko Energy sales personnel immediately before unpacking.

1. Crane unloading

When unloading by crane, please use special tooling. Please select the lifting tool with sufficient tension according to the weight and size of the module before hoisting. When hoisting, please adjust the position of the sling to keep the center of gravity of the module stable, which should be on the top of the packing box.

Use wooden boards or other fixtures of the same width to prevent the slings from squeezing the case and causing the components to break. Please operate the spreader at a constant speed, when the lifting is close to the ground, place the box gently in a relatively flat position.

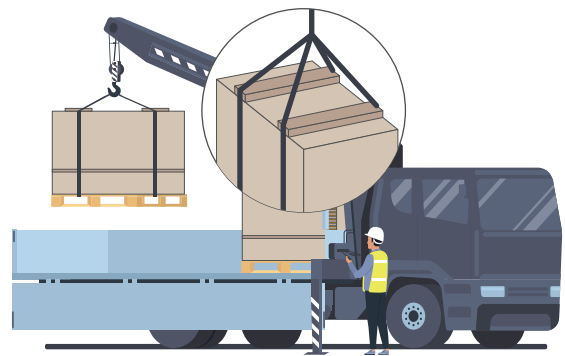

It is strictly prohibited to install photovoltaic modules under meteorological conditions with wind force greater than 6 (Beaufort wind scale), heavy rain or heavy snow.

2. Forklift unloading

The height of the loading and unloading platform should be the same as the bottom of the transportation vehicle.

Keep the straight line speed of forklift within 5km/h and the turning speed within 3km/h. Please avoid sudden stop and rapid start.

If the packing box blocks the sight of the forklift driver, it is recommended to drive the forklift in reverse during transport, and arrange special supervision and command to prevent the collision of personnel or items resulting in the occurrence of personnel injury accident or module damage due to the falling of package box.

After transportation to the installation site, choose a flat hard ground for placement.

Considerations for module turnover and transportation 3.7.2

- When using forklift to transport modules, please ensure that the fork length meets the requirements to avoid module tilting due to uneven force.

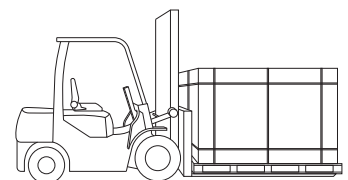

- When opening the packing box, please place the modules to be unpacked at a distance of 20-30cm from the wall or another row of modules, and then remove the row. After removing the cable tie of the fixed modules, slowly lean the modules against the wall or another row of modules to prevent them from falling.

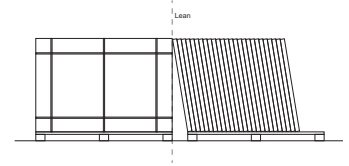

- Please handle the installation modules gently. Do not lift the modules by pulling the junction box or cables under any circumstances. Two or more people must hold the edges of the modules with both hands.

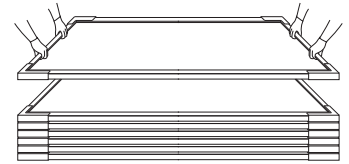

Considerations for module storage and placement 3.7.3

- Please store the packing box of modules in a clean, dry place with relative humidity below 85%. The storage temperature should be between -20 °C and 50 °C.

- In any circumstances, keep the junction box and cables of the modules clean and dry.

- Please store the modules in a ventilated, rain-proof, dry area. When stored outdoors, the modules must be protected from rain or moisture using relevant rainproof materials.

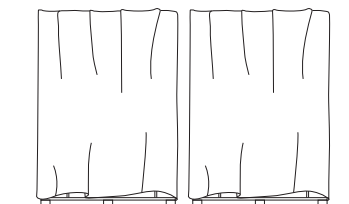

- For the storage of scattered modules, please stack the vertical modules flat on the empty row. The first module should be placed with the glass side up, and the following ones placed with the glass side down. A maximum of 25 modules can be stacked together.

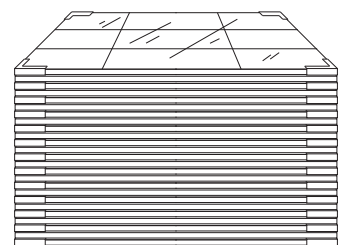

- If the modules need to be transported for long distance or stored for long period, do not open the original packaging. Please keep the wrapping film and packaging carton intact. It's recommended to place modules in a standard warehouse for long-term storage, and conduct regular inspections. Once there is an abnormal tilt, please take enforcement measures in time under the precondition of ensuring personal safety.

04 Installation conditions

Location and working environment 4.1

- Aiko Energy modules are recommended to be installed in a $-20^{\circ}\text{C}\sim 50^{\circ}\text{C}$ environment, with an extreme working ambient temperature of $-40^{\circ}\text{C}\sim 85^{\circ}\text{C}$ and a humidity less than 85%RH.
- Aiko Energy modules are designed to operate up to 2000 m above sea level.
- Do not artificially concentrate sunlight on PV modules.
- When installing solar modules on the roof, always leave a safe working area between the edge of the roof and the external edge of the PV module array.
- When stacking modules on the roof, double check the roof loads and make a construction organization plan meeting the applicable standards.
- Modules shall be positioned to receive adequate sunlight and avoid shading the module surfaces in part or in whole (by trees, buildings, clothes, tools or packing materials).
- Modules shall be installed in a well-ventilated position to ensure adequate air circulation on the back and sides of the module and allow immediate dissipation of heat produced during module operation.
- When modules are used in areas exposed to high wind or snow pressure, supports and fixings shall be designed according to local design standards to keep external loads within the maximum mechanical strength that modules can withstand.
- In areas (coastal areas, factories, volcanic areas, farmlands) exposed to salt fog, sulfide or ammonia gas, corrosion can occur at the connection between the module and the racking or at the ground connection. Anticorrosive materials (e.g., stainless steel or aluminum materials) must be used in contact with PV modules and the mounting position must be protected against rust.

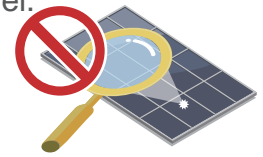

Tilt angle selection

4.2

The tilt angle of PV modules is the angle between the PV module and the horizontal ground. Different tilt angles shall be selected for different projects according to local conditions.

All modules in the same array shall be of the same orientation and angle. Different orientations and angles will result in different total solar irradiation absorbed by modules, leading to output mismatch that degrades system operating efficiency.

In order for the modules to reach their maximum annual power generation capacity, it is important to choose the optimal orientation and tilt angle of the modules at the location so that the sunlight can still shine on the modules between 9am and 15pm even in the shortest day of sunlight of the year. The optimal tilt angle of PV arrays shall be designed by taking into account the multi-year mean monthly irradiance, direct irradiance, scattering irradiance, wind speed and other climate conditions at the location. PV modules should be tilted at an angle to receive the maximal annual irradiance. Angles shall be selected by considering natural conditions such as local wind load, snow load and avoidance of water and dust collection on module surfaces.

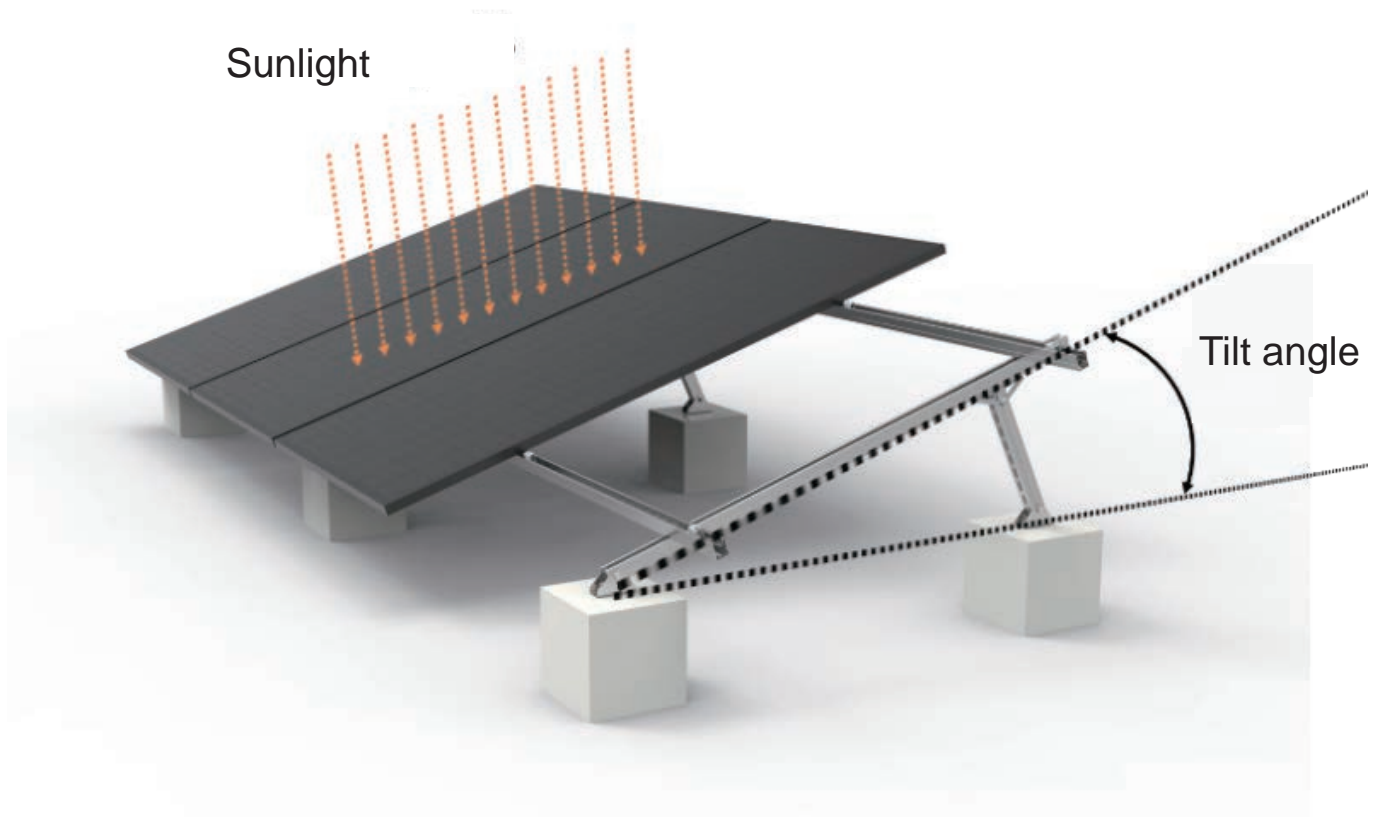

05 Mechanical installation

General requirements

5.1

- Make sure that the modules are properly installed and the racking systems are adequately fastened. Module mounting rackings shall be constructed of anticorrosive, ultraviolet resistant materials.

- Modules shall be firmly secured to the rackings.

Higher racking systems are used in areas exposed to heavy snowfalls. This prevents long-time snow coverage at the lowest point of modules. The lowest point of modules shall be

- kept at a height to prevent shading by weeds or trees.

When modules are installed parallel to the roof, a clearance of at least 10 cm is provided

- between the module frame and the surface of the roof.

- The minimum mounting distance between adjacent modules is 10 mm.

The module loads described herein are test values. According to the installation requirements of IEC 61215-2, maximum design load shall be calculated with a safety coefficient of at least 1.5 times. Project design loads must be based on project location, climate, racking structure and applicable standards. Design loads are determined by racking suppliers and engineers. Please observe both the local laws and regulations and the instructions of structural engineers.

Mechanical installation of single glass modules

5.2

Aiko Energy single glass modules can be connected to the racking system using pressure clamps. Modules must be mounted as recommended and illustrated below. Other mounting configurations may be used provided that consultation is made with, and prior written consent is received from, Aiko Energy. Failure to do so will invalidate our warranty.

Mounting pressure clamps

5.2.1

Specialized pressure clamps are used to mount modules as shown below.

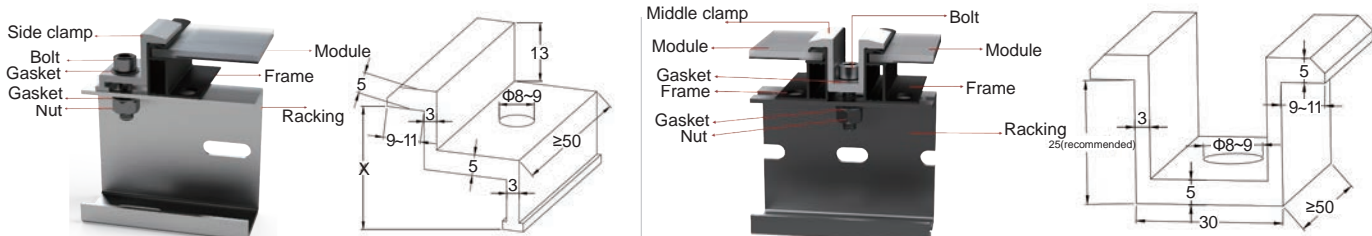

Pressure clamps should not come into contact with the glass surface of the module and must not deform the frame. Be sure to avoid shadowing effect from the pressure clamp.

Be sure that pressure clamps will not fail due to deformation or corrosion while the entire module is under load. Pressure clamps ≥ 50 mm in length and ≥ 3 mm in thickness are recommended. The overlapped distance between the pressure clamp and the module frame, D , shall be at least 7 mm but no more than 10 mm.

Installation diagram of single glass modules and corresponding loads

5.2.2

Single glass modules can be installed using pressure clamps. Following are the installation diagram and corresponding loads.

Here, distance and length are provided in mm; pressure is provided in Pa.

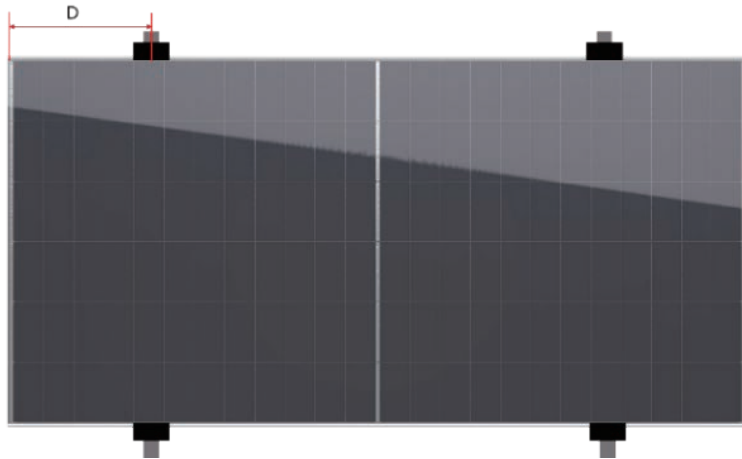

Mounting pressure clamps on the long side, with crossbeam perpendicular to the long side frame

Note: The installation method below is based on experiment.

Module model	Module size L*W*H(mm)	Installation method	
		Mounting pressure clamps on the long side	Installation range
AIKO-A***-MAH54Mb AIKO-A***-MAH54Mw	1722*1134*35/40 1706*1134*35/40	+5400/-2400	$300 \leq D \leq 400$
AIKO-B***-MAH54Mb AIKO-B***-MAH54Mw	1722*1134*35/40 1706*1134*35/40	+5400/-2400	$300 \leq D \leq 400$
AIKO-P***-MAH54Mb AIKO-P***-MAH54Mw	1722*1134*35/40 1706*1134*35/40	+5400/-2400	$300 \leq D \leq 400$
AIKO-A***-MAH72Mb AIKO-A***-MAH72Mw	2278*1134*35/40 2255*1134*35/40	+5400/-2400	$400 \leq D \leq 450$
AIKO-B***-MAH72Mb AIKO-B***-MAH72Mw	2278*1134*35/40 2255*1134*35/40	+5400/-2400	$400 \leq D \leq 450$
AIKO-P***-MAH72Mb AIKO-P***-MAH72Mw	2278*1134*35/40 2255*1134*35/40	+5400/-2400	$400 \leq D \leq 450$

06 Electrical installation

Electrical performance

6.1

The electrical performance parameters of Aiko Energy PV modules are detailed in the product specification of PV modules. There is a $\pm 3\%$ error between nominal electrical parameters of PV modules (e.g., I_{sc} and V_{oc}) and measurements under standard test conditions. Standard test conditions (STC) for PV modules: irradiance 1000 W/m²; battery temperature 25°C; air quality AM1.5. The maximum system voltage of Aiko Energy PV modules is 1500 V.

When modules are connected into a string, the final voltage is the sum of the voltages of individual modules; when they are connected in parallel, the final current is the sum of the currents of individual modules, as shown below. Modules with different electrical parameters cannot be connected into a string.

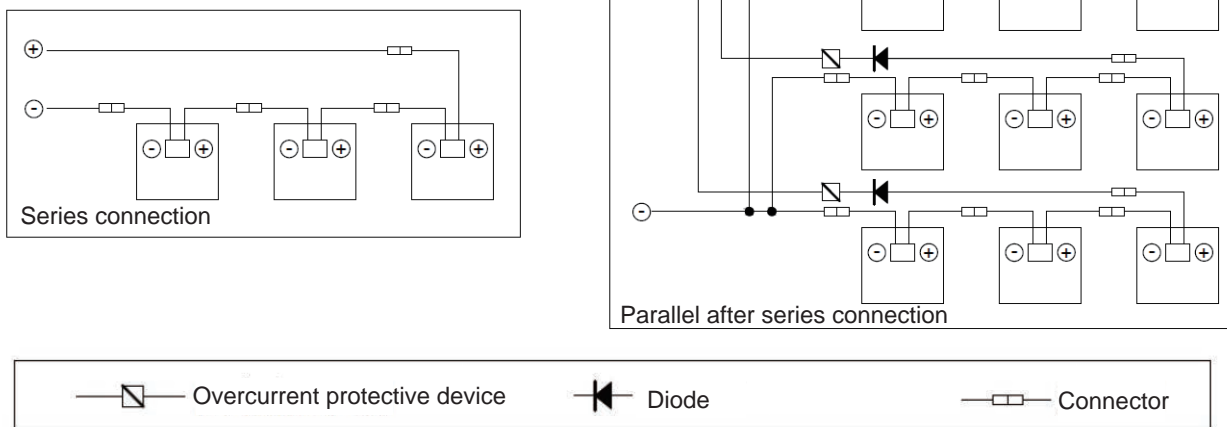

If the module is passed through by a reverse current greater than the maximum fuse current of the module, the module shall be protected with an overcurrent protector of the same specification. If more than two strings are connected in parallel, each module string shall be protected with an overcurrent protector as shown above.

The string voltage must not exceed the maximum voltage that the system can withstand or the maximum input power of the inverter or other electrical devices installed in the system. To ensure this, the open circuit voltage of the array shall be calculated at the minimum expected ambient temperature at that location. The following formula may be used:

$$\text{Maximum system voltage} \geq N \times V_{oc} \times [1 + \beta \cdot (T_{min} - 25)]$$

Where:

N — number of modules connected in series

V_{oc} — open circuit voltage of each module (refer to product nameplate or specification)

β — thermal coefficient of open circuit voltage for the module (refer to the specification)

T_{min} — lowest ambient temperature

Cables and connections

6.2

The junction box for modules is designed for IP68 and composed of connected cables and IP68 connectors. The module has a positive and a negative PV cable connected into the junction box and a plug-and-play connector connected at the other end. Using the positive connector of the module to connect the negative connector of the adjacent module connects the two modules in series.

Use specialized solar cables and appropriate connectors according to local electrical and installation standards, codes and regulations at the location, and make sure that the cables are electrically and mechanically sound.

Aiko Energy modules use specialized PV cables which have a cross sectional area of 4 mm² and are ultraviolet resistant. All other cables used to connect the DC system shall be of similar (or better) specification. Aiko Energy recommends that all cables are run in appropriate conduits and sited away from areas prone to water collection.

In field connection, copper cables with a minimum cross sectional area of 4 mm² which are rated for 90°C and are UV resistant shall be used as PV connecting lines.

The minimum bending radius of the cable is 43mm.

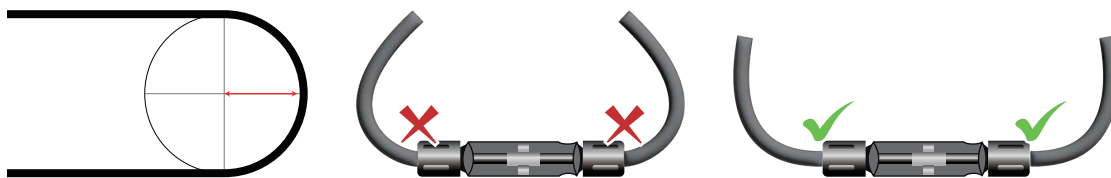

Connector

6.3

Take care to keep the connectors dry and clean. Make sure that the connector nuts are tightened before making any connection. Do not connect while the connectors are wet or otherwise abnormal. As connectors provide IP68 protection only when the positive and negative poles are fully mated, please connect modules as soon as possible after installation or take proper steps to prevent water vapor and dust from coming into the connector.

Avoid exposing the connector to direct sunlight and water. Avoid exposing the connector directly to ground surface or roof.

Make sure that all electrical connections are secure. Incorrect connection can result in electrical arcing and shocks.

Do not mate different models of connectors together.



07 Grounding

Modules are designed with an anodized anticorrosive aluminum alloy frame as a rigid support. Module frames must be grounded to ensure safe use and protect the module against lightning and electrostatic damage. Grounding must be made with the grounding device in full contact with the interior of the aluminum alloy and penetrating the oxide film on the frame surface.

Grounding hardware items include grounding screws, flat washers, puncture gaskets and grounding wires. All these hardware items shall be constructed of stainless steel except grounding wires. Grounding conductors or grounding wires shall be copper wires. Grounding conductors shall be connected to the ground through an appropriate grounding electrode. Third-party grounding devices meeting local electrical installation standards at the location may be used for grounding Aiko Energy modules. Grounding device shall be installed according to the operation manual provided by the manufacturer.

Following is the recommended grounding method:

There are $\Phi 4.2$ mm grounding holes on surface C of the module frame. Use a separate grounding wire and accessories to connect the aluminum alloy frame of PV modules and connect the grounding wire to the ground. We recommend using M4×12 mm grounding bolts accompanied by M4 nuts, star washers and flat washers.

We recommend torquing grounding bolts to 3~7 Nm and using 4 mm² copper wires as grounding wires.

Unused module mounting holes on the frame may also be used for grounding purposes.

Components

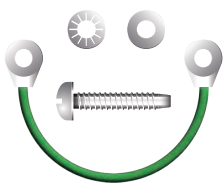

Sketch map

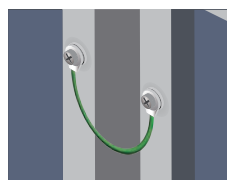

Connection mode

The star washer, flat washer, and ground wire are placed in sequence, threaded through the ground hole using screws, and tightened to secure the adjacent modules.

We recommend using the following method to ground correctly, as shown in the figure.

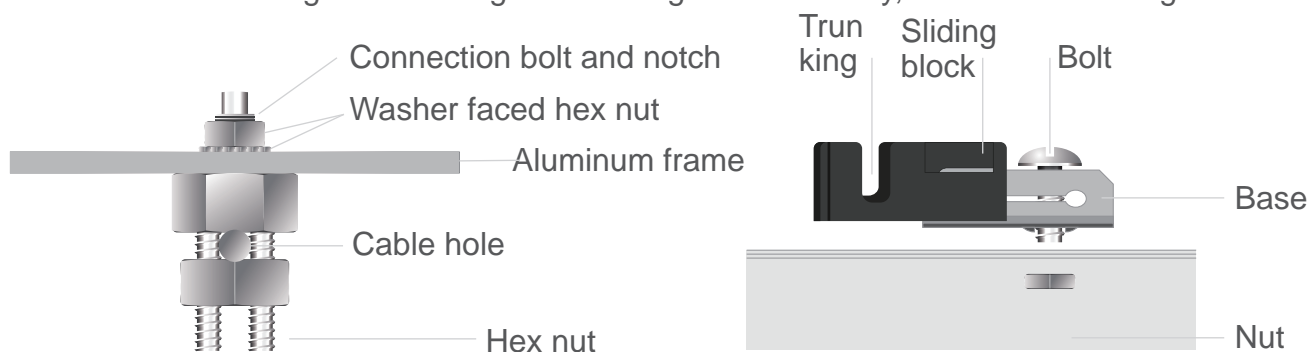

08 Maintenance of PV modules

Modules shall be inspected and maintained on a regular basis, especially within the warranty period, which is an obligatory responsibility of the user. Any damage or other visible abnormalities of the module shall be reported to Aiko Energy customer service upon discovery.

Cleaning

8.1

The power output of modules is related to incident light intensity and can be reduced by dust collection or other shadings. Dirt on modules must be cleaned up immediately.

The cleaning frequency depends on the degree of dirt collection. Modules installed at an adequate tilt angle will allow rainwater to clean the module surfaces, thereby reducing the cleaning frequency.

We recommend cleaning the glass surface of the module with a clear water-wetted sponge. Do not clean modules with a detergent containing acid or alkali. Do not clean modules with a hair brush or other rough surface tools.

We recommend cleaning modules in the early morning or late afternoon or other periods of time when the light is weak and the module temperature is comparatively lower.

Cleaning methods

Method A: High pressure water cleaning

Water quality requirement

- PH:6-8;
- Water hardness - calcium carbonate concentration: $\leq 600\text{mg/L}$;
- Recommended use of soft water cleaning;
- Recommended maximum water pressure is 4MPa(40bar)



Water



Absolute ethyl alcohol



Dust-free gloves



Dust-free paper

Method B: Compressed air cleaning

Air pressure cleaning is recommended when cleaning soft stains (like dust) on modules. This technique can be applied as long as the on-site cleaning effect is good enough.

Method C: Wet test cleaning

If there is too much stain on the surface of the module, it's recommended to carefully use an insulating brush, sponge or other soft cleaning tool.

Ensure that any brushes or agitating tools are made of insulating material to minimize the risk of electric shock and that they do not scratch the glass or aluminum frame.

For oil stains, it's recommended to use an environmentally friendly cleaner.

Method D: Robot cleaning

If the cleaning robot is used for dry cleaning, the brush material is required to be soft plastic, so that the glass surface and aluminum alloy frame of the module will not be scratched during and after cleaning. The cleaning robot should not be too heavy. The module damage and power degradation caused by improper cleaning of the cleaning robot are not covered by Aiko Energy warranty.

Visual checks of the modules

8.2

Visually checks for visual defects on modules, such as:

- Whether the module glass is broken;
- Whether the back cover of the module is cracked or otherwise abnormal;
- Whether the junction box is damaged or the cable is broken;
- Whether the module is shaded by foreign matter or shadows;
- Check whether the bolts fixing the module to the racking are loose or corroded and adjust or replace them if necessary;
- Check whether the modules are well-grounded;

Checks of connectors and cables

8.3

It is recommended to perform preventive examinations every six months, such as:

- whether the connectors are properly sealed and the cables are properly fastened;
- whether the sealant of the junction box is cracked.

Safe

Intelligent

Low-carbon



Shenzhen Aiko Digital Energy Technology Co., Ltd.

16-28 floor, Building A, Terra City Building, Terra 4 Road No. 66, Futian District, Shenzhen

Tel: 400-0099-366

Website: <http://www.aikosolar.com/>