

1. Packing List

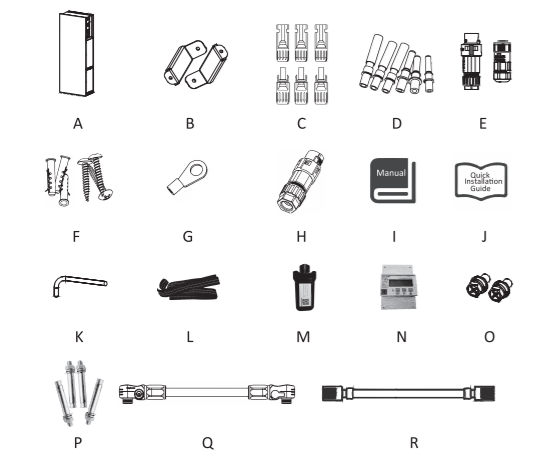

Object	Quantity	Description	Object	Quantity	Description
A	1	Energy station	J	1	Quick installation guide
B	2	Brackets	K	1	Offset ring spanner
C	6	PV connectors (Only for Hybrid) (3* positive, 3* negative)	L	1	Binding band
D	6	PV pin contacts (Only for Hybrid) (3* positive, 3* negative)	M	1	WIFI/LAN/GPRS (Optional)
E	2	AC connectors	N	1	Meter
F	3	Expansion tubes & Expansion screws	O	2	Hexagonal screws
G	1	Earth terminal	P	4	Expansion screws (For ground installation)
H	1	Communication connector	Q	3	Battery Power cables (1*320mm, 1*620mm, 1*900mm)
I	1	Product manual	R	1	Communication cable

2. Installation Steps

Please make sure the energy station will be installed with a proper distance as shown below.

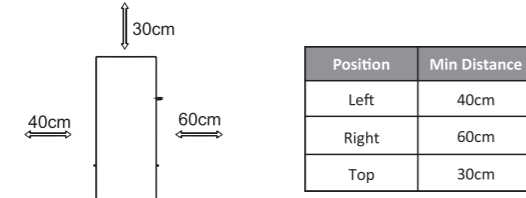

Position	Min Distance
Left	40cm
Right	60cm
Top	30cm

A. Energy station installation

1. Wall mounting
Choose a clean and stable wall surface for installation.
Use hexagonal screws to fix the brackets on the back of the All-In-One.
Aim the All-In-One towards the wall and mark position of two holes from brackets.

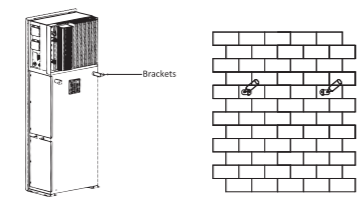

Drill holes on the marks with a diameter of 6mm drill. Insert the expansion screws into the hole.

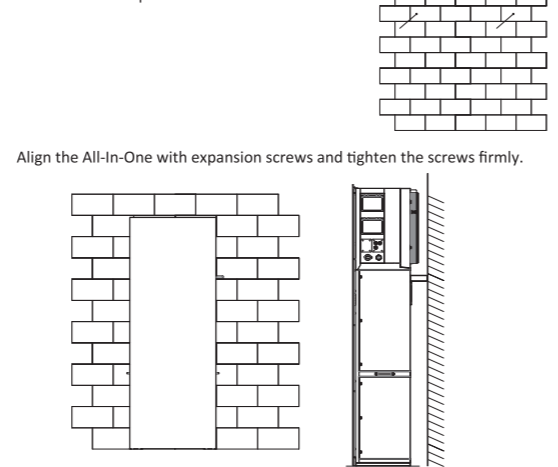

2. Ground installation
Choose a flat and stable ground for installation and place the All-In-One on that ground.
Mark position of the four corners on the bottom of the All-In-One then remove the All-In-One.
Drill holes on the marks, make sure the depth is at least 60mm, the diameter of the holes is about 13-14 mm. The hole which closest to the wall should keep a minimum distance of 170mm from the wall.

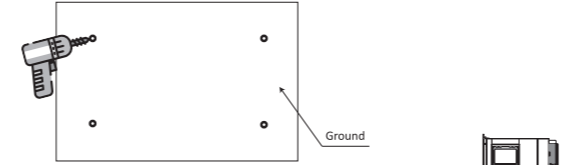

Insert the expansion screw into the ground.
Place the All-In-One back to the ground, align the All-In-One with four expansion screws and tighten the screws firmly.

Note: For easy installation, instead of using the All-In-One for hole remarks, you can remark the hole with the installation guide (Size is same as All-In-One).

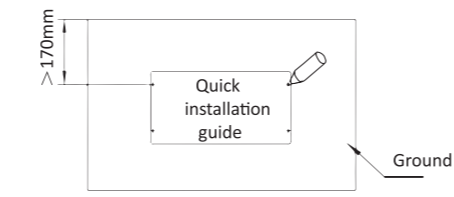

B. Battery installation

Remove the brackets on both sides of the battery. There are eight screws on the left and right sides (4*left, 4*right).

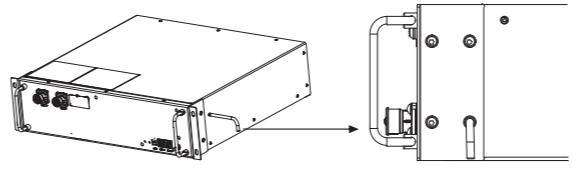

Lift and push the battery into the All-In-One as shown in the figure below.

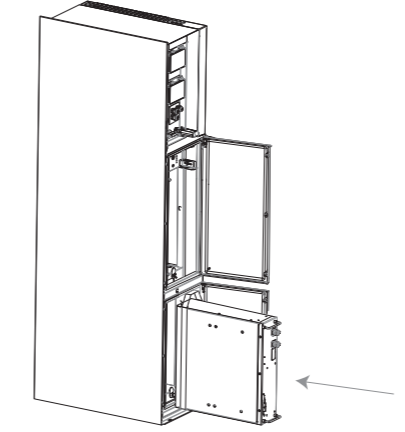

3. Serial Port Connections

Communication interface between the inverter and Meter/485/DRM/Ethernet/BMS/Parallel 1/Parallel 2 are as follows with RJ45 connectors which should be inserted corresponding port in the inverter.

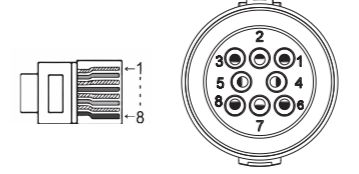

PIN	1	2	3	4	5	6	7	8
Meter/485	485A	485B	Meter 485B	Meter 485A	/	/	RY_CON	+12V
DRM	DRM1	DRM2	DRM3	DRM4	+3.3V	DRM0	GND	GND
Ethernet	TX+	TX-	RX+	/	/	RX-	/	/
Parallel 1	/	/	/	Parallel_CANH	Parallel_CANL	/	BMS_CANH	BMS_CANL
Parallel 2	E_STOP	GND_COM	/	Parallel_CANH	Parallel_CANL	/	/	/
BMS	/	GND	BMS_485B	BMS_CANL	BMS_CANH	/	/	BMS_485A

Note:
Compatible Meter type: DTSU666 (CHINT).

4. Wiring Steps

PV Wiring (For Hybrid version Only)
Choose 12 AWG wire to connect the PV module.
Trim 6mm of insulation from the wire end.



Separate the DC connector (PV) as below.

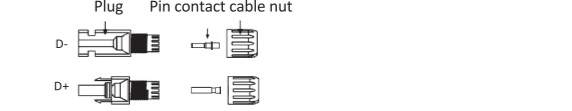

Insert striped cable into pin contact and ensure all conductor strands are captured in the pin contact.

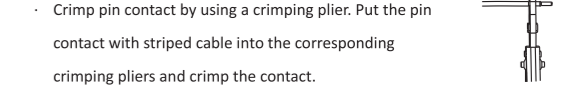

Insert pin contact through the cable nut to assemble into back of the male or female plug. When you feel or hear a "click" the pin contact assembly is seated correctly.

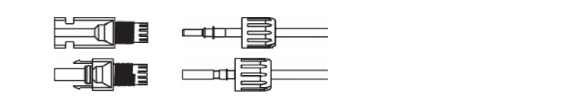

QUICK INSTALLATION GUIDE

- Unlock the DC connector:
- Use the specified wrench tool.
- When separating the DC+ connector, push the tool down from the top.
- When separating the DC- connector, push the tool down from the bottom.
- Separate the connectors by hand.

Battery Wiring

A. Connection of battery power line and communication line

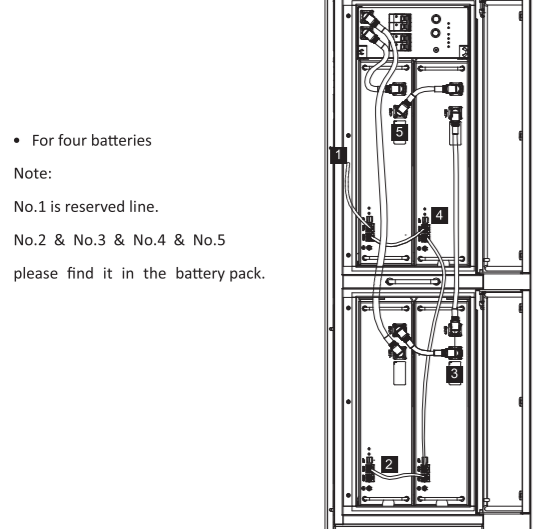

• For four batteries
Note:
No.1 is reserved line.
No.2 & No.3 & No.4 & No.5 please find it in the battery pack.

B. Connection of battery ground cable

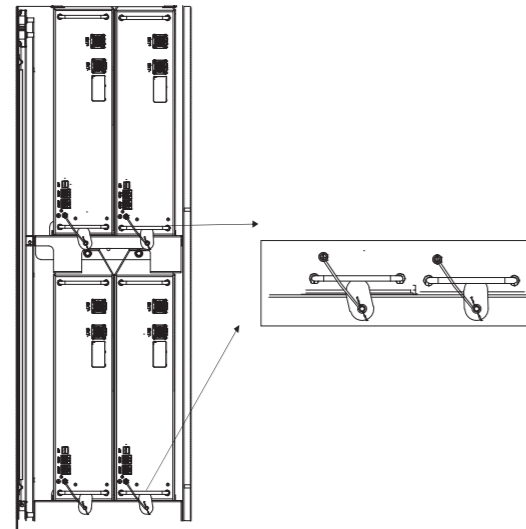

Note:
Four ground cables please find it in the battery pack.

Grid Wiring

Cable dimensions

Model (kW)	5.0	6.0	8.0	10.0
Cable (ON-GRID)	4.0mm ²	4.0mm ²	4.0mm ²	4.0mm ²
Cable (EPS)	4.0mm ²	4.0mm ²	4.0mm ²	4.0mm ²
Micro-Breaker	25A	25A	25A	25A

- Trim all the wires to 52.5mm and the PE wire to 55mm.
- Use the crimping pliers to trim 12mm of insulation from all wire ends as shown in the picture.



L1/L2/L3: Brown/Red/Green or Yellow Wire
N: Blue/Black Wire
PE: Yellow & Green Wire
Note: Please refer to local cable type and color for actual installation.

A. EPS Wiring

- Set the parts on the cable.

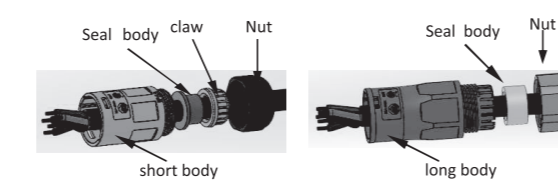

- Crimp wires, screw twisting torque 0.8+/-0.1N·m.

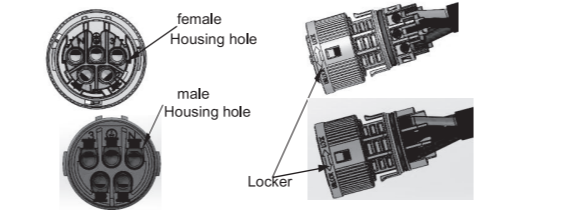

- Push Housing into Body.



- Put the sealing body and yarn trapper into the main body, screw the lock nut into the main body, and the torque is (2.5 +/- 0.5N·m).

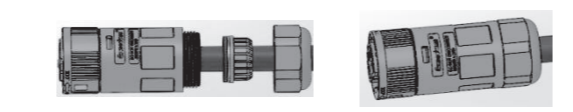

- Insert the male end into the female end. For the rotation direction of the lock, please refer to the LOCK mark on the assembly.

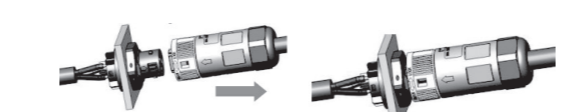

B. ON-GRID Wiring

- Separate the ON-GRID plug into three parts as below.

1. Hold the middle part of the female insert, rotate the back shell to loosen it, and detach it from female inset.
2. Remove the cable nut (with rubber insert) from the back shell.

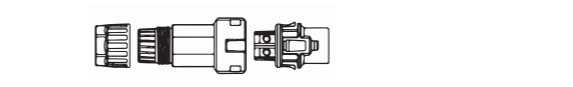

- Slide the cable nut and then the back shell onto the cable.

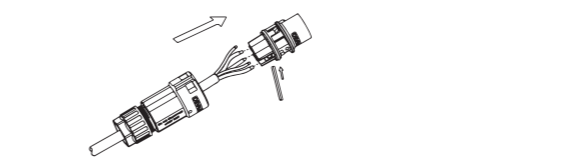

- Push the threaded sleeve into the socket, tighten up the cap on the terminal.

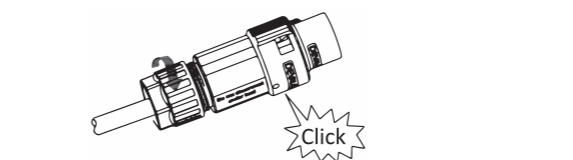

- Push the threaded sleeve to connection terminal until both are locked tightly on the energy station.

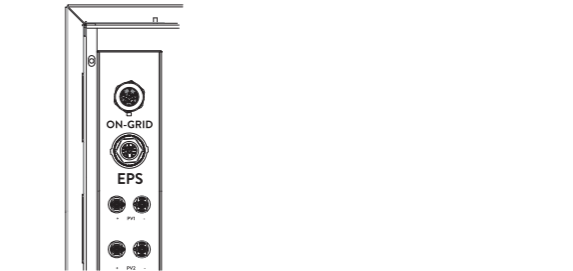

- Remove the ON-GRID connector: Press the bayonet out of the slot with a small screwdriver or the unlock tool and pull it out, or unscrew the threaded sleeve, then pull it out.

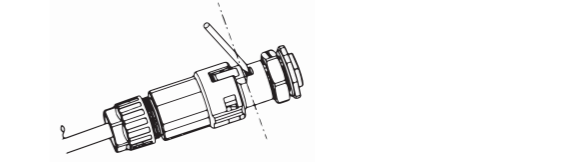

Grounding Wiring

Use the crimping pliers to press the ground cable into the ground terminal, screw the ground screw with screwdriver as shown below.



5. Energy Station Start-Up

Please refer to the following steps to start up the energy station.

1. Ensure the energy station fixed well.
2. Make sure all wirings are completed.
3. Make sure the meter is connected well.
4. Make sure the battery is connected well.
5. Make sure the external EPS contactor is connected well (if needed).
6. Make sure the BMS buttons and battery switch are off.
7. Turn on the PV/DC switch (for Hybrid version only), AC breaker, EPS breaker and battery breaker.
8. Enter the settings page, default password is '0000', select START / STOP and set it to start (long press "enter" to quickly go to the START / STOP page).

Note:
• When starting energy station for the first time, the country code will be set by default to the local settings. Check if the country code is correct.
• Set the time on the inverter using the button or by using the APP.

6. Energy Station Switch Off

Please refer to the following steps to switch off the energy station.

1. Enter the settings page, select START / STOP and set it to stop.
2. Turn off the PV/DC switch (for Hybrid version only), AC breaker, EPS breaker and battery breaker.
3. Wait 5 min before you open the upper lid (if in need of repair).